

## CSS SuperStop

### End Cap for Pre-Insulated Pipes

#### Product Description



The CSS SuperStop is shipped in cartons. The adhesive is protected from contamination by an inner liner.

#### Equipment List



Propane tank, hose, torch & regulator; Wire brush, grater, triangular scraper; Knife, roller, rags & ethanol (min. 99%) cleanser; Temperature measuring device; Standard safety equipment; gloves, goggles, hard hat

#### Flame Intensity

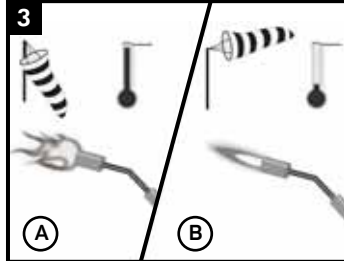

Adjust the flame according to outside conditions.

- a. Use bluish-yellow flame for low wind, higher temps.
- b. Use blue flame for high wind, lower temperatures.

Always aim the torch perpendicular to the pipe and move in a circumferential direction.

#### SuperStop Preparation

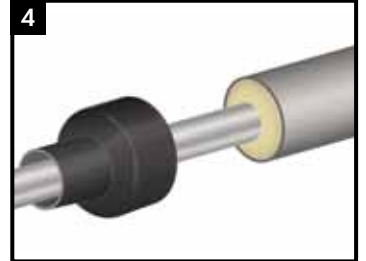

Before welding together the carrier pipe, slide the Canusa SuperStop (CSS) over, and - for surface preparation - as far away from the application area as possible.

#### General Drying

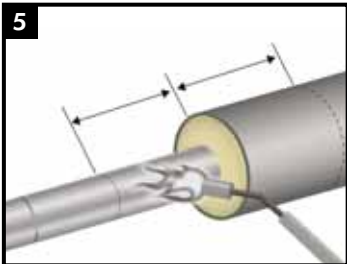

Dry the surfaces of the jacket and carrier pipes with the torch.

#### Pipe Preparation

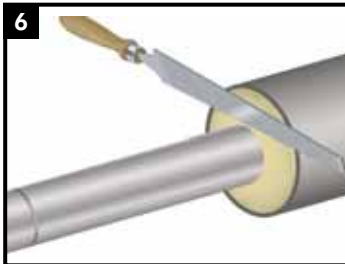

Using the grater, remove any wet or excess PUR foam from the end of the pre-insulated pipe.

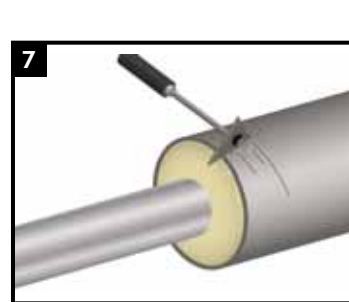

Using a triangular scraper, clean the edge and top of the jacket pipe to remove any sharp corners and burrs.

#### Surface Preparation

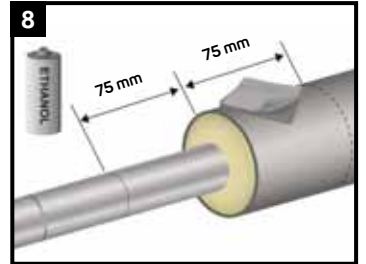

De-grease the surface of the jacket pipe using a grease and lint-free rag soaked in ethanol (min. 99%).

#### Surface Abrasion

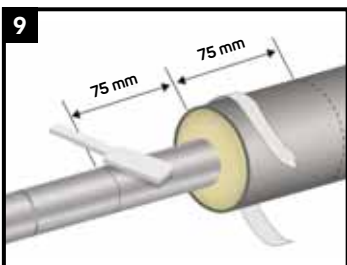

Using sandpaper (40-60 grade) or a wire brush, roughen the surface of the jacket pipe and the service pipe.

#### Final Surface Cleaning

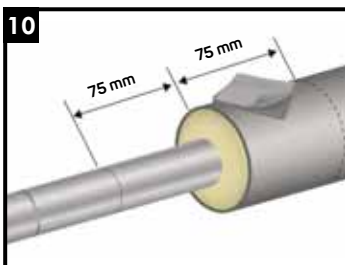

Using a dry, grease and lint-free rag, clean the roughened surface to remove any polyethylene or sand particles.

#### Pre-Warm

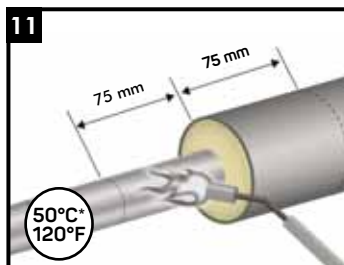

Using the torch, pre-warm the surface to be covered with the SuperStop (jacket pipe and service pipe) to a minimum of 50°C. **Using the temperature measuring device, ensure the correct temperature has been reached.**

\*Alternative adhesives are available and pre-heat temperatures may vary. Please contact your local Canusa-CPS representative for more details.

#### SuperStop Installation



Remove the inner release liner from both ends of the Canusa SuperStop.



Using a gloved hand, push the Canusa SuperStop into the side of the pre-insulated pipe as far as possible.

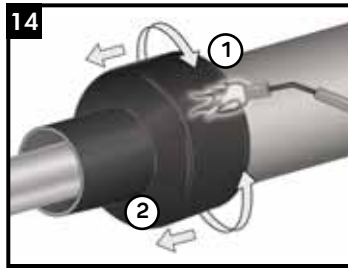

Using the torch and heating circumferentially, begin shrinking the larger end of the Canusa SuperStop around the jacket pipe starting from the end and working towards the middle. Use a gloved hand, press the SuperStop firmly into the wall of the pre-insulated pipe.

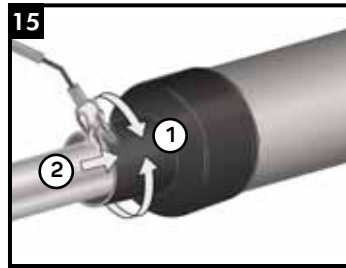

Shrink the SuperStop around the entire circumference of the service pipe starting from the middle and working towards the edge. **Continue shrinking until the SuperStop is fully recovered.**

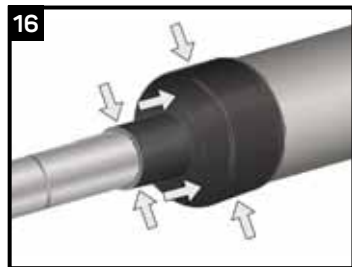

Finish the installation by heating the entire Canusa SuperStop and pressing it firmly into the jacket pipe with a gloved hand.



Visually inspect the installed SuperStop for the following:

- SuperStop is in full contact with both pipes.
- The SuperStop is pressed in to the jacket pipe completely.
- The SuperStop has fully conformed to the profile.

### Backfilling Guidelines

After shrinking is complete, allow the Canusa SuperStop to cool to below the intended operating temperature of the pipeline before backfilling. To prevent damage to the Canusa SuperStop, use selected backfill material (no sharp stones or large particles).

### Storage & Safety Guidelines

To ensure maximum performance, store Canusa products in a dry, ventilated area. Keep products sealed in original cartons and avoid exposure to direct sunlight, rain, snow, dust or other adverse environmental elements. Avoid prolonged storage at temperatures above 35°C (95°F) or below -20°C (-4°F). Product installation should be done in accordance with local health and safety regulations.

These installation instructions are intended as a guide for standard products. Consult your Canusa representative for specific projects or unique applications.

### Canusa-CPS A division of Shawcor Ltd.

#### Head Office

25 Bethridge Road  
Toronto, ON, Canada M9W 1M7  
Tel: +1 416 743 7111  
Fax: +1 416 743 5927

#### Canada

Dome Tower St. 2200,  
333-7th Avenue SW  
Calgary, AB, Canada T2P 2Z1  
Tel: +1 403 218 8207  
Fax: +1 403 264 3649

#### Americas

5875 N. Sam Houston Pkwy W,  
Suite 200  
Houston, TX, USA 77086  
Tel: +1 281 886 2350  
Fax: +1 281 886 2353

#### Middle East

Plot # 37-WR43, Sector no.: ICAD III  
Musaffah South, PO Box 2621  
Abu Dhabi, The United Arab Emirates  
Tel: +971 2 204 9800

#### Europe, Africa & Russia

Dellaertweg 9-E, Gebouw  
"Le Carrefour"  
2316 WZ Leiden,  
The Netherlands (NL)  
Tel: +31 71 80 802 70  
Fax: +31 71 80 802 71

#### Asia-Pacific

101 Thomson Road,  
#11-03 United Square  
307591 Singapore  
Tel: +65 6749 8918  
Fax: +65 6749 8919

### Quality Management system registered to ISO 9001

Canusa warrants that the product conforms to its chemical and physical description and is appropriate for the use stated on the installation guide when used in compliance with Canusa's written instructions. Since many installation factors are beyond our control, the user shall determine the suitability of the products for the intended use and assume all risks and liabilities in connection therewith. Canusa's liability is stated in the standard terms and conditions of sale. Canusa makes no other warranty either expressed or implied. All information contained in this installation guide is to be used as a guide and is subject to change without notice. This installation guide supersedes all previous installation guides on this product. E&OE

Part No. 99060-216

IG\_CSS\_rev017